

VistaScan Ultra View - mit Computeranbindung

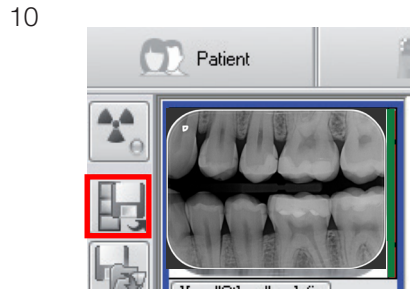
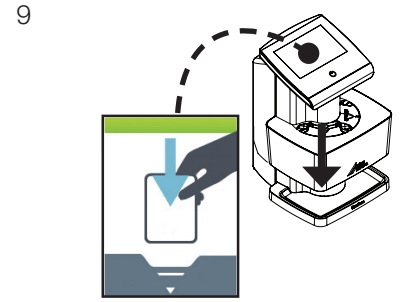
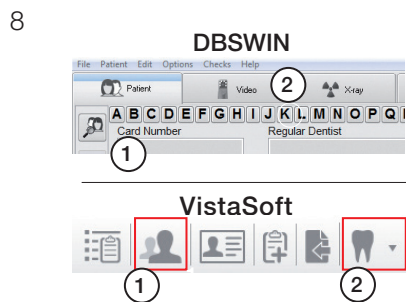
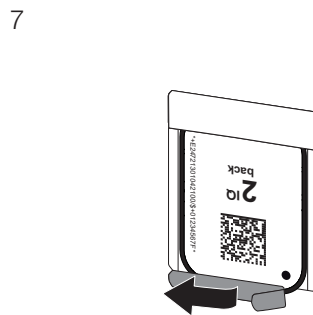
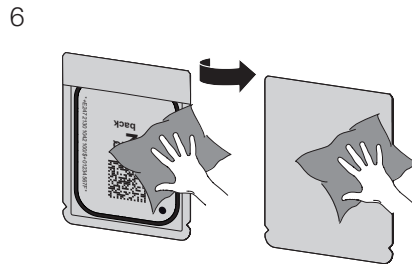
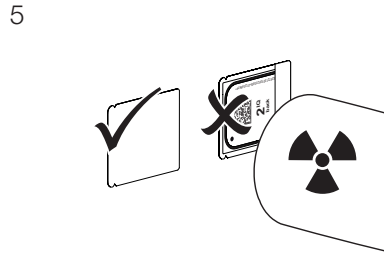
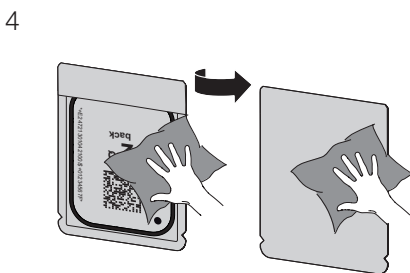
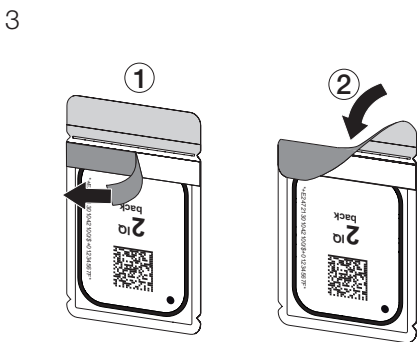
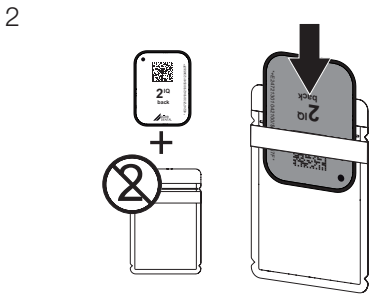
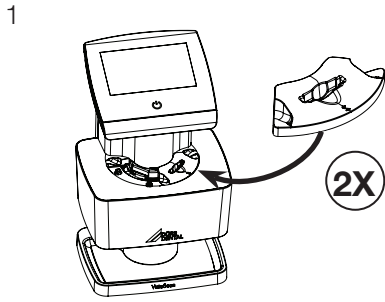

Manufactured for / Distributed by:
 DÜRR DENTAL SE | Höpfigheimer Str. 17 | 74321 Bietigheim-Bissingen | Germany
 Fon: +49 7142 705-0 | www.duerrdental.com | info@duerrdental.com

Air Techniques, Inc. | 1295 Walt Whitman Road | Melville, New York 11747- 3062, USA
 Air Techniques, a Dürr Dental Company

2170100021L41



Medical Device Safety Service
 Schiffgraben 41
 30175 Hannover, Germany



VistaScan Ultra View - ohne Computeranbindung

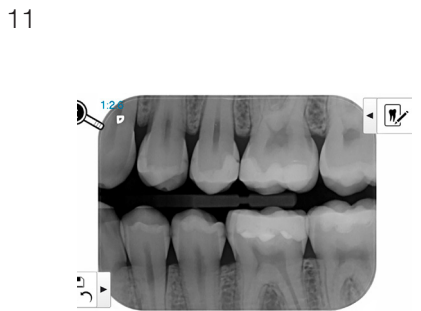
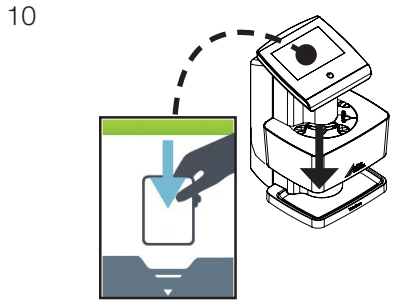
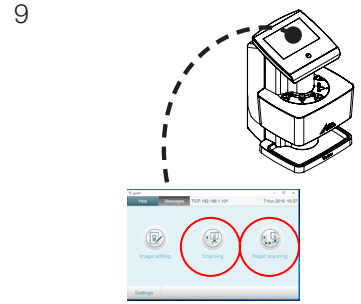
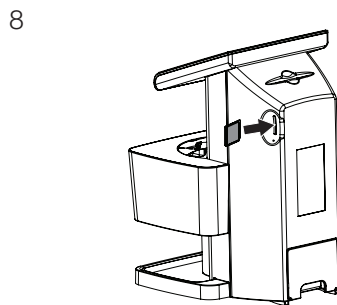
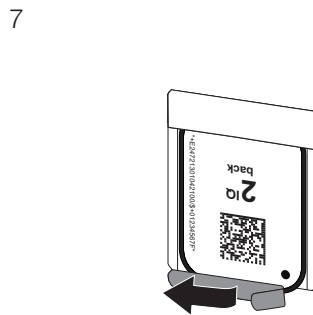
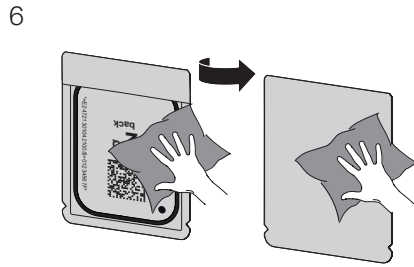
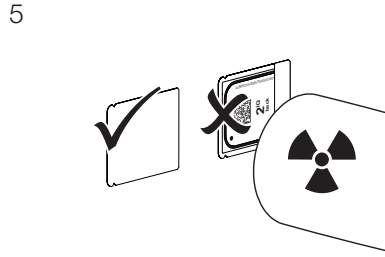
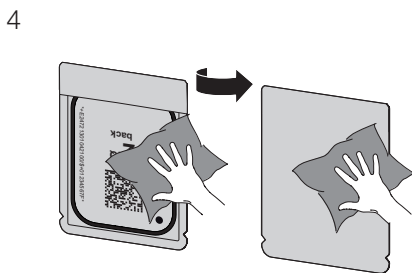
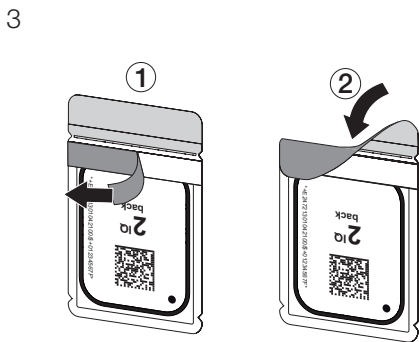
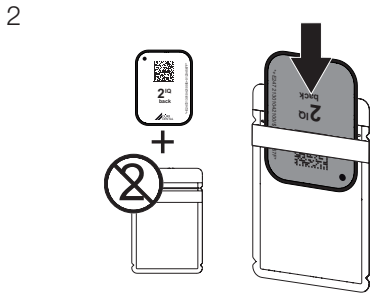
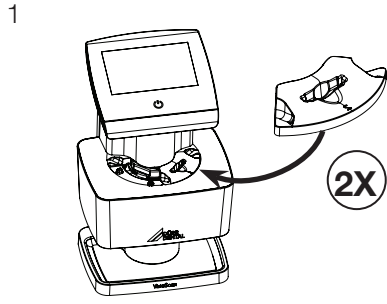

VistaScan Ultra View - with computer

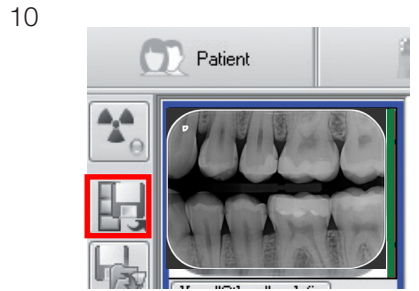
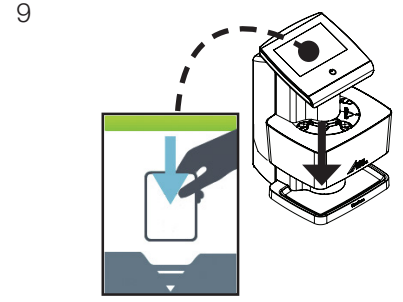
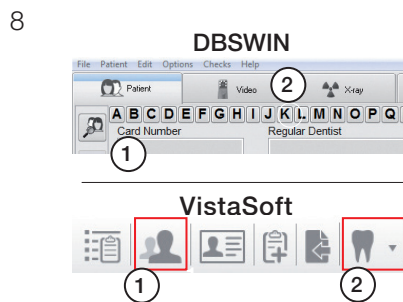
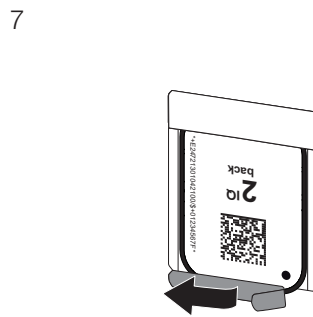
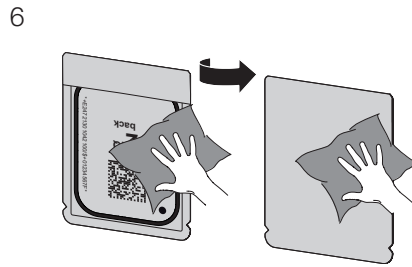
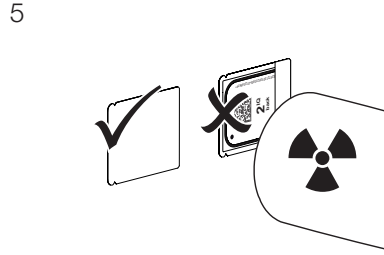
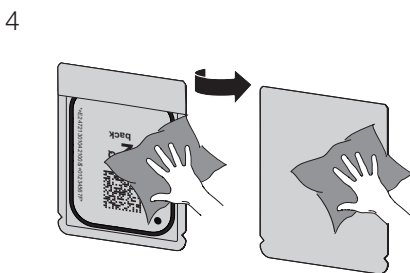
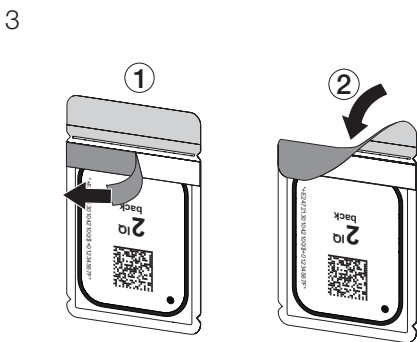
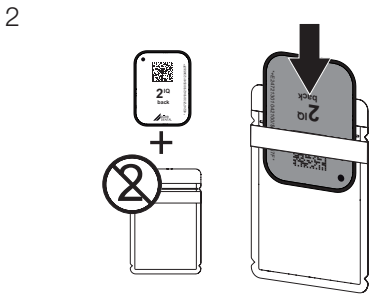
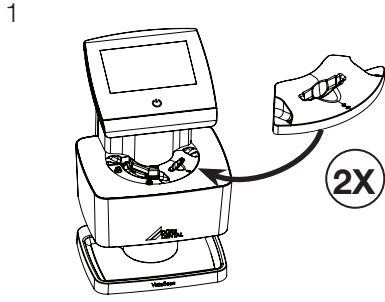

Manufactured for / Distributed by:
 DÜRR DENTAL SE | Höpfigheimer Str. 17 | 74321 Bietigheim-Bissingen | Germany
 Fon: +49 7142 705-0 | www.duerrdental.com | info@duerrdental.com

Air Techniques, Inc. | 1295 Walt Whitman Road | Melville, New York 11747- 3062, USA
 Air Techniques, a Dürr Dental Company

2170100021L41



Medical Device Safety Service
 Schiffgraben 41
 30175 Hannover, Germany



VistaScan Ultra View - without computer

